

SIRIUS HRI

High pressure discharge lamps designed to provide brilliant light effects.



Áreas de aplicación

- not relevant
- Club & Disco
- Stage & Theatre
- not relevant
- Architecture & Architainment

Características del producto

- Lightweight and compact reflector lamps with ECG
- High luminance through very short arc and high pressure
- Produces brilliant light effects
- Stable light output over the entire lifetime
- Long lifetime
- Easy lamp replacement
- Approved by leading moving lighting fixture companies



Hoja de datos gama de productos

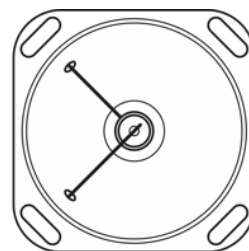
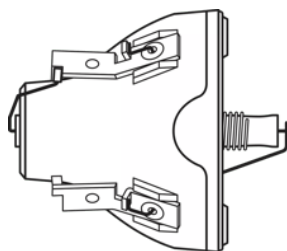
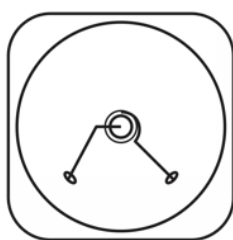
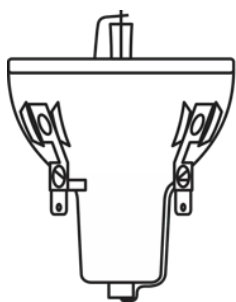

SIRIUS HRI 100W

SIRIUS HRI 132W

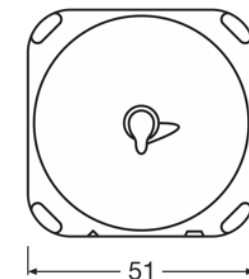
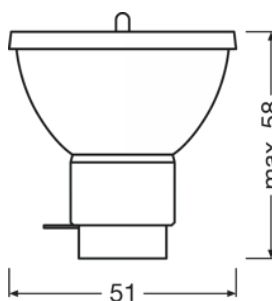
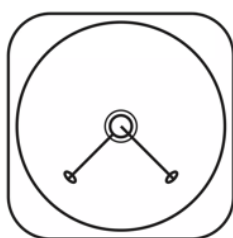
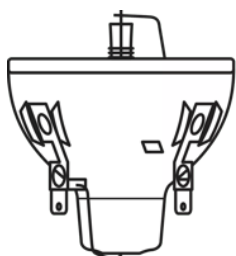

SIRIUS HRI 132W

SIRIUS HRI 251W

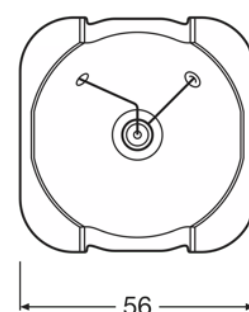
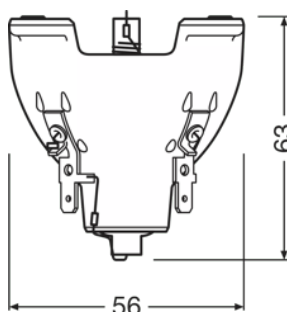
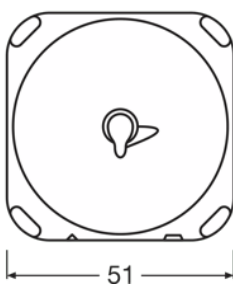
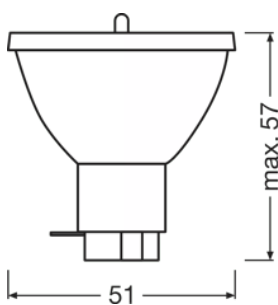

SIRIUS HRI 295 W

SIRIUS HRI 330W

Hoja de datos gama de productos

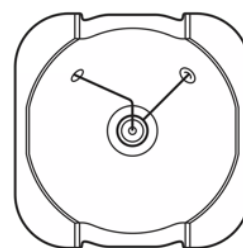
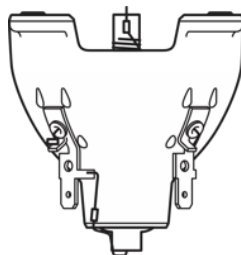
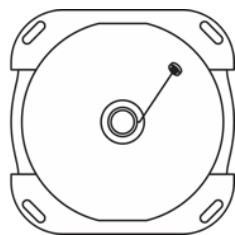
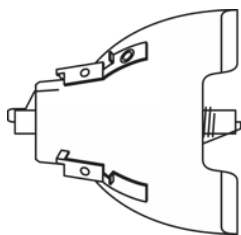

SIRIUS HRI 330W

SIRIUS HRI 330W

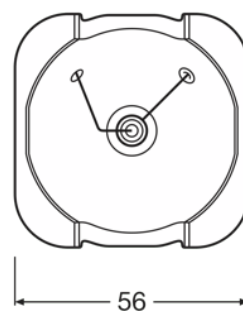
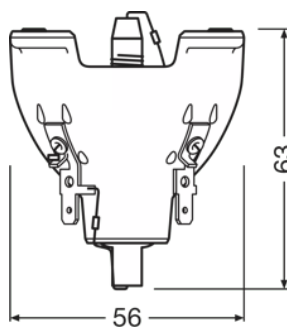
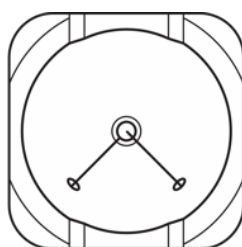
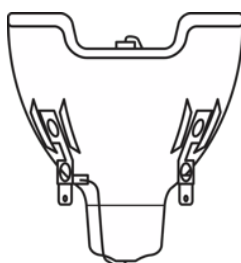

SIRIUS HRI 330W X8

Sirius HRI 330W XL

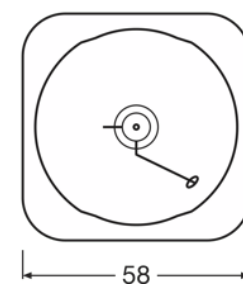
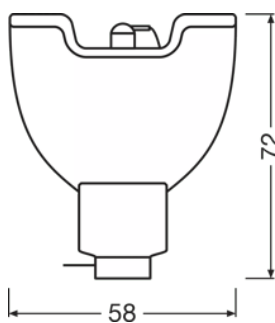
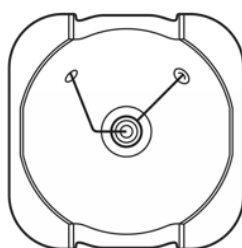
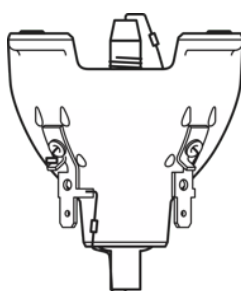

Sirius HRI 330W XL

SIRIUS HRI 371W

Hoja de datos gama de productos

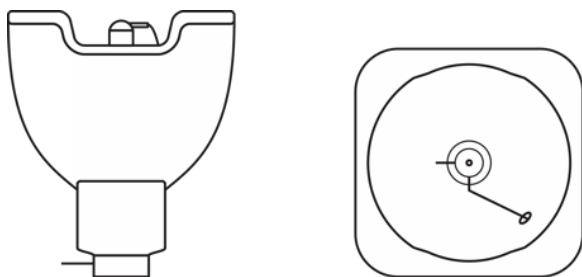

SIRIUS HRI 371W

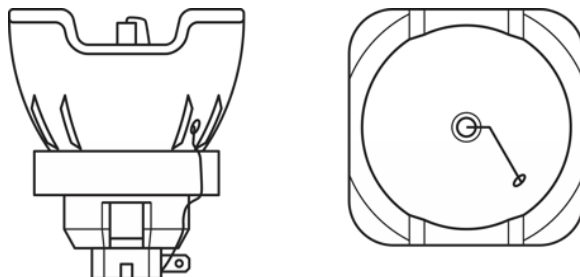

SIRIUS HRI 440W

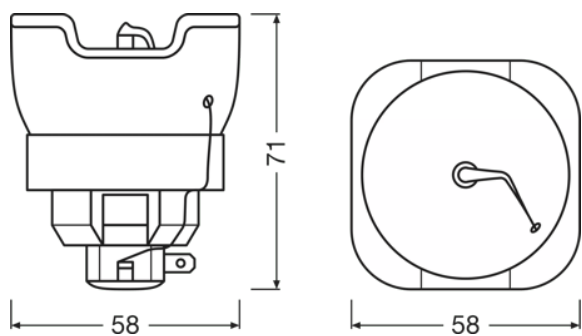

SIRIUS HRI 580 F

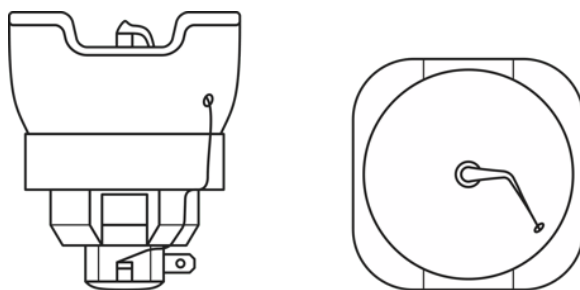

SIRIUS HRI 580 F

Hoja de datos gama de productos

Datos técnicos

Descripción del producto	Información general del producto	Datos eléctricos	Datos Fotométricos	
	Category	Potencia nominal	Flujo luminoso	Working distance
SIRIUS HRI 100 W	CORE	100 W	3680 lm	30 mm
SIRIUS HRI 132 W SC	CORE	132 W	5150 lm	37.7 mm
SIRIUS HRI 140 W RO	CUSTOMIZED	140 W	5400 lm	37.7 mm
SIRIUS HRI 190 W+	CORE	190 W	8100 lm	34.5 mm
SIRIUS HRI 230 W	CORE	230 W	9500 lm	34.5 mm
SIRIUS HRI 231 W	VALUE	231 W	10800 lm	34.5 mm
SIRIUS HRI 251 W	VALUE	251 W	12000 lm	38 mm
SIRIUS HRI 260 W PRO	PRO	260 W	13500 lm	34.5 mm
SIRIUS HRI 280 W	CORE	280 W	11500 lm	34.5 mm
SIRIUS HRI 280 W RO	CUSTOMIZED	280 W	11500 lm	34.5 mm
SIRIUS HRI 281 W	VALUE	281 W	13000 lm	34.5 mm
SIRIUS HRI 295 W	CORE	295 W	11300 lm	34.5 mm
SIRIUS HRI 310 W	CORE	310 W	15000 lm	36.5 mm
SIRIUS HRI 310 W RO	CUSTOMIZED	310 W	13500 lm	48 mm
SIRIUS HRI 310 W PRO	PRO	310 W	15500 lm	37.4 mm
SIRIUS HRI 310 W S PRO	PRO	310 W	15500 lm	31.4 mm
SIRIUS HRI 311 W	VALUE	311 W	14500 lm	31.4 mm
SIRIUS HRI 330 W	CORE	330 W	18000 lm	31 mm
SIRIUS HRI 330 W X8	CUSTOMIZED	330 W	18000 lm	37.4 mm
SIRIUS HRI 330 W XL	CORE	330 W	16500 lm	36 mm
SIRIUS HRI 371 W +	CORE	371 W	18300 lm	37.4 mm
SIRIUS HRI 371 W S +	CORE	371 W	19800 lm	31.4 mm
SIRIUS HRI 371 W	VALUE	371 W	18300 lm	31.4 mm
SIRIUS HRI 371 W S	VALUE	371 W	19800 lm	37.4 mm
SIRIUS HRI 381 W S	CUSTOMIZED	381 W	20000 lm	34.4 mm
SIRIUS HRI 380 W Pro	PRO	380 W	20000 lm	31.4 mm
SIRIUS HRI 380 W S PRO	PRO	380 W	20000 lm	31.4 mm
SIRIUS HRI 382 W S	CORE	382 W	20000 lm	31.4 mm
SIRIUS HRI 382 W	CORE	382 W	21000 lm	37.4 mm
SIRIUS HRI 420 W	CORE	420 W	22000 lm	34.4 mm
SIRIUS HRI 420 W S	CORE	420 W	21000 lm	34.4 mm
SIRIUS HRI 440 W	CORE	440 W	22000 lm	41 mm
SIRIUS HRI 440 W H	CUSTOMIZED	440 W	18000 lm	60 mm
SIRIUS HRI 440 W +	CORE	440 W	22800 lm	41 mm
SIRIUS HRI 440 W X	CUSTOMIZED	440 W	22800 lm	41 mm
SIRIUS HRI 461 W	VALUE	461 W	24000 lm	41 mm
SIRIUS HRI 461 W S	VALUE	461 W	24000 lm	37.4 mm
SIRIUS HRI 462 W	CORE	462 W	24000 lm	41 mm
SIRIUS HRI 470 W	CORE	470 W	20500 lm	41 mm
SIRIUS HRI 470 W S	CORE	470 W	21500 lm	37.4 mm
SIRIUS HRI 470 W RO	CUSTOMIZED	470 W	19500 lm	48 mm

Hoja de datos gama de productos

Descripción del producto	Información general del producto	Datos eléctricos	Datos Fotométricos	
	Category	Potencia nominal	Flujo luminoso	Working distance
SIRIUS HRI 470 W XL	CORE	470 W	24000 lm	59 mm
SIRIUS HRI 471 W SN	VALUE	471 W	20000 lm	41 mm
SIRIUS HRI 550 W XL	CORE	550 W	28000 lm	59 mm
SIRIUS HRI 550 W	CORE	550 W	28000 lm	41 mm
HRI 580 W F	CUSTOMIZED	580 W	29500 lm	60 mm

Descripción del producto	Physical Attributes & Dimensions			
	Distancia entre electrodos en frío	Casquillo (denominación estándar)	Diámetro	Largo
SIRIUS HRI 100 W	1,0 mm	SPEZIAL	45.0 mm	53.0 mm
SIRIUS HRI 132 W SC	1,0 mm	-	46.0 mm	max. 44 mm
SIRIUS HRI 140 W RO	1,0 mm	-	46.0 mm	max. 44 mm
SIRIUS HRI 190 W+		-	51.0 mm	54.5 mm
SIRIUS HRI 230 W	1,0 mm	-	51.0 mm	54.5 mm
SIRIUS HRI 231 W	1,0 mm	-	51.0 mm	50.0 mm
SIRIUS HRI 251 W		-	51.0 mm	61.0 mm
SIRIUS HRI 260 W PRO	0,9 mm	-	51.0 mm	50.0 mm
SIRIUS HRI 280 W	0,9 mm	-	51.0 mm	54.5 mm
SIRIUS HRI 280 W RO	0,9 mm	-	51.0 mm	54.5 mm
SIRIUS HRI 281 W	1,0 mm	-	51.0 mm	50.0 mm
SIRIUS HRI 295 W		-	51.0 mm	53.5 mm
SIRIUS HRI 310 W		-	51.0 mm	53.5 mm
SIRIUS HRI 310 W RO		-	60.0 mm	67.0 mm
SIRIUS HRI 310 W PRO	0,9 mm	-	58.0 mm	72.0 mm
SIRIUS HRI 310 W S PRO	0,9 mm	-	58.0 mm	72.0 mm
SIRIUS HRI 311 W		-	51.0 mm	50.0 mm
SIRIUS HRI 330 W	1,0 mm	-	56.0 mm	63.0 mm
SIRIUS HRI 330 W X8	1,0 mm	-	58.0 mm	66.0 mm
SIRIUS HRI 330 W XL	1,0 mm	-	56.0 mm	63.0 mm
SIRIUS HRI 371 W +	1,2 mm	-	58.0 mm	72.0 mm
SIRIUS HRI 371 W S +	1,2 mm	-	58.0 mm	72.0 mm
SIRIUS HRI 371 W	1,0 mm	-	58.0 mm	72.0 mm
SIRIUS HRI 371 W S	1,2 mm	-	58.0 mm	72.0 mm
SIRIUS HRI 381 W S		-	58.0 mm	72.0 mm
SIRIUS HRI 380 W Pro		-	58.0 mm	72.0 mm
SIRIUS HRI 380 W S PRO		-	58.0 mm	72.0 mm
SIRIUS HRI 382 W S	1,0 mm	-	58.0 mm	72.0 mm
SIRIUS HRI 382 W	1,0 mm	-	58.0 mm	72.0 mm
SIRIUS HRI 420 W		-	58.0 mm	72.0 mm
SIRIUS HRI 420 W S		-	58.0 mm	72.0 mm
SIRIUS HRI 440 W	1,3 mm	-	58.0 mm	71.0 mm
SIRIUS HRI 440 W H	1,3 mm	-	65.0 mm	60.0 mm
SIRIUS HRI 440 W +		-	58.0 mm	71.0 mm
SIRIUS HRI 440 W X	1,0 mm	-	58.0 mm	71.0 mm

Hoja de datos gama de productos

Descripción del producto	Physical Attributes & Dimensions			
	Distancia entre electrodos en frío	Casquillo (denominación estándar)	Diámetro	Largo
SIRIUS HRI 461 W	1,3 mm	-	60.0 mm	67.0 mm
SIRIUS HRI 461 W S	1,3 mm	-	60.0 mm	67.0 mm
SIRIUS HRI 462 W	-	-	58.0 mm	72.0 mm
SIRIUS HRI 470 W	1,3 mm	-	58.0 mm	71.0 mm
SIRIUS HRI 470 W S	1,3 mm	-	58.0 mm	71.0 mm
SIRIUS HRI 470 W RO	1,2 mm	-	60.0 mm	67.0 mm
SIRIUS HRI 470 W XL	1,3 mm	-	60.0 mm	67.0 mm
SIRIUS HRI 471 W SN	1,3 mm	Side Prong	60.0 mm	67.0 mm
SIRIUS HRI 550 W XL	-	Side Prong	60.0 mm	67.0 mm
SIRIUS HRI 550 W	1.5 mm	Side Prong	60.0 mm	67.0 mm
HRI 580 W F	-	-	65.0 mm	65.0 mm

Descripción del producto	Peso del producto	Diameter (in)	Conector: Presencia [PICOS]	Temp. y condiciones de funcionamiento
				Posición de quemado
SIRIUS HRI 100 W	60.00 g	-	-	Universal
SIRIUS HRI 132 W SC	60.00 g	1.810 in	-	Universal
SIRIUS HRI 140 W RO	60.00 g	-	-	Universal
SIRIUS HRI 190 W+	60.00 g	-	-	-
SIRIUS HRI 230 W	60.00 g	2.008 in	-	Universal
SIRIUS HRI 231 W	60.00 g	-	-	Universal
SIRIUS HRI 251 W	50.00 g	-	-	-
SIRIUS HRI 260 W PRO	60.00 g	-	-	-
SIRIUS HRI 280 W	60.00 g	2.008 in	-	Universal
SIRIUS HRI 280 W RO	65.00 g	-	-	Universal
SIRIUS HRI 281 W	60.00 g	-	-	Universal
SIRIUS HRI 295 W	63.50 g	-	-	-
SIRIUS HRI 310 W	60.00 g	-	-	-
SIRIUS HRI 310 W RO	135.00 g	-	-	Universal
SIRIUS HRI 310 W PRO	130.00 g	-	-	-
SIRIUS HRI 310 W S PRO	130.00 g	-	-	-
SIRIUS HRI 311 W	60.00 g	-	-	-
SIRIUS HRI 330 W	75.00 g	2.008 in	-	Universal
SIRIUS HRI 330 W X8	100.00 g	0.236 in	-	Universal
SIRIUS HRI 330 W XL	75.00 g	0.512 in	-	Universal
SIRIUS HRI 371 W +	130.00 g	-	-	-
SIRIUS HRI 371 W S +	130.00 g	-	-	-
SIRIUS HRI 371 W	130.00 g	-	-	Universal
SIRIUS HRI 371 W S	130.00 g	-	-	Universal
SIRIUS HRI 381 W S	130.00 g	-	-	-
SIRIUS HRI 380 W Pro	130.00 g	-	-	-
SIRIUS HRI 380 W S PRO	130.00 g	-	-	-

Hoja de datos gama de productos

Descripción del producto	Peso del producto	Diameter (in)	Conector: Presencia [PICOS]	Temp. y condiciones de funcionamiento
				Posición de quemado
SIRIUS HRI 382 W S	136.00 g		Yes	
SIRIUS HRI 382 W	136.00 g		Yes	
SIRIUS HRI 420 W	130.00 g			
SIRIUS HRI 420 W S	130.00 g			
SIRIUS HRI 440 W	100.00 g			Universal
SIRIUS HRI 440 W H	160.00 g			Universal
SIRIUS HRI 440 W +	135.50 g			
SIRIUS HRI 440 W X	135.50 g			
SIRIUS HRI 461 W	140.00 g			Universal
SIRIUS HRI 461 W S	140.00 g			Universal
SIRIUS HRI 462 W	130.00 g			
SIRIUS HRI 470 W	103.60 g			Universal
SIRIUS HRI 470 W S	103.60 g			Universal
SIRIUS HRI 470 W RO	140.00 g			Universal
SIRIUS HRI 470 W XL	140.00 g			Universal
SIRIUS HRI 471 W SN	140.00 g			Universal
SIRIUS HRI 550 W XL	140.00 g			
SIRIUS HRI 550 W	140.00 g			
HRI 580 W F	160.00 g			

Descripción del producto	Enfriamiento	Duración de vida	Información medioambiental y regulatoria Information according Art. 33 of EU Regulation (EC) 1907/2006 (REACH)	
		Average Rated Life	Identificador principal del artículo	Nº de declaración en la base de datos SCIP
SIRIUS HRI 100 W	Refrigeración forzada	6000 hr	4052899329119 4052899321656	No contiene sustancias declarables
SIRIUS HRI 132 W SC	Refrigeración forzada	6000 hr	4052899028708 4052899011335 4052899197404	No contiene sustancias declarables
SIRIUS HRI 140 W RO	Refrigeración forzada	6000 hr	4052899258969 4052899224056	No contiene sustancias declarables
SIRIUS HRI 190 W+		3000 hr	4052899475397 4008321866592	No contiene sustancias declarables
SIRIUS HRI 230 W	Refrigeración forzada	2500 hr	4008321810311	No contiene sustancias declarables
SIRIUS HRI 231 W		2000 hr	4062172128681 4062172212311 4052899553521	No contiene sustancias declarables
SIRIUS HRI 251 W		3000 hr	4062172212458 4062172212434	No contiene sustancias declarables

Hoja de datos gama de productos

Descripción del producto	Enfriamiento	Duración de vida	Información medioambiental y regulatoria Information according Art. 33 of EU Regulation (EC) 1907/2006 (REACH)	
		Average Rated Life	Identificador principal del artículo	Nº de declaración en la base de datos SCIP
SIRIUS HRI 260 W PRO		6000 hr	4062172118927 4062172118941	No contiene sustancias declarables
SIRIUS HRI 280 W	Refrigeración forzada	2000 hr	4008321810342	No contiene sustancias declarables
SIRIUS HRI 280 W RO		2000 hr	4052899110397	No contiene sustancias declarables
SIRIUS HRI 281 W		2000 hr	4052899553552 4062172128704	No contiene sustancias declarables
SIRIUS HRI 295 W		2500 hr	4062172283328 4062172283304	No contiene sustancias declarables
SIRIUS HRI 310 W		2500 hr	4062172202169 4062172202183	No contiene sustancias declarables
SIRIUS HRI 310 W RO		3000 hr	4062172140867 4062172140843	No contiene sustancias declarables
SIRIUS HRI 310 W PRO		1500 hr	4062172169424 4062172085304	No contiene sustancias declarables
SIRIUS HRI 310 W S PRO		1500 hr	4062172169455 4062172122825	No contiene sustancias declarables
SIRIUS HRI 311 W		2500 hr	4062172169363	No contiene sustancias declarables
SIRIUS HRI 330 W	Refrigeración forzada	1500 hr	4008321810373	No contiene sustancias declarables
SIRIUS HRI 330 W X8		1500 hr	4052899140325 4052899224346 4052899140295	No contiene sustancias declarables
SIRIUS HRI 330 W XL		1500 hr	4052899195431	No contiene sustancias declarables
SIRIUS HRI 371 W +		3000 hr	4062172110327 4062172110341	No contiene sustancias declarables
SIRIUS HRI 371 W S +		3000 hr	4062172110372 4062172110396	No contiene sustancias declarables
SIRIUS HRI 371 W		1500 hr	4062172057004 4062172056984	No contiene sustancias declarables

Hoja de datos gama de productos

Descripción del producto	Enfriamiento	Duración de vida	Información medioambiental y regulatoria Information according Art. 33 of EU Regulation (EC) 1907/2006 (REACH)	
		Average Rated Life	Identificador principal del artículo	Nº de declaración en la base de datos SCIP
SIRIUS HRI 371 W S		1500 hr	4062172056939 4062172056953	No contiene sustancias declarables
SIRIUS HRI 381 W S		2500 hr	4062172226240 4062172226226	No contiene sustancias declarables
SIRIUS HRI 380 W Pro		2500 hr	4062172168601 4062172168625	No contiene sustancias declarables
SIRIUS HRI 380 W S PRO		2500 hr	4062172168311 4062172168335	No contiene sustancias declarables
SIRIUS HRI 382 W S		1500 hr	4062172033541 4062172326100	No contiene sustancias declarables
SIRIUS HRI 382 W		2500 hr	4062172047135 4062172326131	No contiene sustancias declarables
SIRIUS HRI 420 W		2500 hr	4062172192750 4062172192736	No contiene sustancias declarables
SIRIUS HRI 420 W S		2500 hr	4062172192682 4062172392938 4062172393225 4062172192705 4062172392891 4062172393201	No contiene sustancias declarables
SIRIUS HRI 440 W	Refrigeración forzada	1500 hr	4052899259096 4052899222212 4052899587892 4052899570566 4052899553644	No contiene sustancias declarables
SIRIUS HRI 440 W H		1000 hr	4052899576735	No contiene sustancias declarables
SIRIUS HRI 440 W +		1500 hr	4062172348874 4062172047333	No contiene sustancias declarables
SIRIUS HRI 440 W X		1500 hr	4062172017442	No contiene sustancias declarables
SIRIUS HRI 461 W		1500 hr	4052899553613	No contiene sustancias declarables
SIRIUS HRI 461 W S		1500 hr	4052899553583	No contiene sustancias declarables
SIRIUS HRI 462 W		2000 hr	4062172302128 4062172302104	No contiene sustancias declarables

Hoja de datos gama de productos

Descripción del producto	Enfriamiento	Duración de vida	Información medioambiental y regulatoria Information according Art. 33 of EU Regulation (EC) 1907/2006 (REACH)	
		Average Rated Life	Identificador principal del artículo	Nº de declaración en la base de datos SCIP
SIRIUS HRI 470 W		1500 hr	4062172169332 4052899580961	No contiene sustancias declarables
SIRIUS HRI 470 W S		1500 hr	4052899580985 4062172169301	No contiene sustancias declarables
SIRIUS HRI 470 W RO		1500 hr	4052899477018	No contiene sustancias declarables
SIRIUS HRI 470 W XL		1500 hr	4062172017473 4062172168281	No contiene sustancias declarables
SIRIUS HRI 471 W SN		1500 hr	4062172040358	No contiene sustancias declarables
SIRIUS HRI 550 W XL		1000 hr	4062172168212 4062172168236	No contiene sustancias declarables
SIRIUS HRI 550 W		1500 hr	4062172008761 4062172078122	No contiene sustancias declarables
HRI 580 W F		1000 hr	4062172085267	No contiene sustancias declarables

Descripción del producto	Lista de candidatos Sustancia 1
SIRIUS HRI 100 W	No contiene sustancias declarables
SIRIUS HRI 132 W SC	No contiene sustancias declarables
SIRIUS HRI 140 W RO	No contiene sustancias declarables
SIRIUS HRI 190 W+	No contiene sustancias declarables
SIRIUS HRI 230 W	No contiene sustancias declarables
SIRIUS HRI 231 W	No contiene sustancias declarables
SIRIUS HRI 251 W	No contiene sustancias declarables

Hoja de datos gama de productos

Descripción del producto	Lista de candidatos Sustancia 1
SIRIUS HRI 260 W PRO	No contiene sustancias declarables
SIRIUS HRI 280 W	No contiene sustancias declarables
SIRIUS HRI 280 W RO	No contiene sustancias declarables
SIRIUS HRI 281 W	No contiene sustancias declarables
SIRIUS HRI 295 W	No contiene sustancias declarables
SIRIUS HRI 310 W	No contiene sustancias declarables
SIRIUS HRI 310 W RO	No contiene sustancias declarables
SIRIUS HRI 310 W PRO	No contiene sustancias declarables
SIRIUS HRI 310 W S PRO	No contiene sustancias declarables
SIRIUS HRI 311 W	No contiene sustancias declarables
SIRIUS HRI 330 W	No contiene sustancias declarables
SIRIUS HRI 330 W X8	No contiene sustancias declarables
SIRIUS HRI 330 W XL	No contiene sustancias declarables
SIRIUS HRI 371 W +	No contiene sustancias declarables
SIRIUS HRI 371 W S +	No contiene sustancias declarables
SIRIUS HRI 371 W	No contiene sustancias declarables
SIRIUS HRI 371 W S	No contiene sustancias declarables

Hoja de datos gama de productos

Descripción del producto	Lista de candidatos Sustancia 1
SIRIUS HRI 381 W S	No contiene sustancias declarables
SIRIUS HRI 380 W Pro	No contiene sustancias declarables
SIRIUS HRI 380 W S PRO	No contiene sustancias declarables
SIRIUS HRI 382 W S	No contiene sustancias declarables
SIRIUS HRI 382 W	No contiene sustancias declarables
SIRIUS HRI 420 W	No contiene sustancias declarables
SIRIUS HRI 420 W S	No contiene sustancias declarables
SIRIUS HRI 440 W	No contiene sustancias declarables
SIRIUS HRI 440 W H	No contiene sustancias declarables
SIRIUS HRI 440 W +	No contiene sustancias declarables
SIRIUS HRI 440 W X	No contiene sustancias declarables
SIRIUS HRI 461 W	No contiene sustancias declarables
SIRIUS HRI 461 W S	No contiene sustancias declarables
SIRIUS HRI 462 W	No contiene sustancias declarables
SIRIUS HRI 470 W	No contiene sustancias declarables
SIRIUS HRI 470 W S	No contiene sustancias declarables
SIRIUS HRI 470 W RO	No contiene sustancias declarables

Hoja de datos gama de productos

Descripción del producto	Lista de candidatos Sustancia 1
SIRIUS HRI 470 W XL	No contiene sustancias declarables
SIRIUS HRI 471 W SN	No contiene sustancias declarables
SIRIUS HRI 550 W XL	No contiene sustancias declarables
SIRIUS HRI 550 W	No contiene sustancias declarables
HRI 580 W F	No contiene sustancias declarables

Hoja de datos gama de productos

Instrucciones de seguridad

Debido a su elevada luminancia, la radiación UV y la elevada presión interna durante su funcionamiento, las lámparas SIRIUS HRI solo pueden funcionar en carcasas cerradas fabricadas especialmente para ese fin. Debe garantizarse con filtros adecuados que la radiación UV se vea reducida hasta un nivel aceptable. El mercurio se libera si se rompe la lámpara. Se requieren precauciones de seguridad especiales. Se dispone de información acerca de la seguridad y la manipulación a petición, o bien en el folleto que se adjunta con la lámpara, o en las instrucciones de funcionamiento.

Consejos de aplicación

Para más información detallada sobre la aplicación y gráficos vea la hoja de datos del producto.

Aviso

Sujeto a cambios sin aviso. Excepto errores y omisiones. Asegúrese de utilizar la emisión más reciente.